

Pure Lead - High Temp



The NSB HT RED Battery® delivers long life in unreliable grid conditions even at high temperatures.

- Pure lead electrochemistry greatly increases temp and corrosion resistance while reducing component aging
- Thin plates deliver large surface area high power density and low resistance
- Design life 15+ years at 20°C (68°F)
- Extra long life at high temp operation 40°C (104°F)
- EUROBAT design life definition: Very Long Life (12+ years)
- Advanced 3 stage terminal design to ensure leak-free operation - brass terminals provide maximum performance
- Approved as non-hazardous cargo for ground, sea and air transport DOT 49CFR173.159(d), (i) and (ii)
- Fast recharging
- High cyclic performance
- Flame retardant (UL 94 VO) and LOI of at least 28%
- Shelf life of up to 24 months
- Operating temperature range -40°C to +65°C (-40°F to 149°F)
- State-of-the-art automated manufacturing ensures consistency and reliability
- High modulus Polyphenylene Oxide (PPO) plastic materials designed to withstand extended elevated operating temperatures and maintain high battery compression essential for reliable operation
- Non-halogenated thermally sealed plastic casing

NSB 145FT HT RED

Nominal Technical Specifications

Dimensions

Height	253 mm	Width	160 mm
Length	427 mm	Weight	45 kg

Electrical

Terminal	Female M8 x 1.25
Terminal torque	8.0 Nm (71 in-lbs)
1 hr capacity to 1.70VPC @ 20/25°C (68/77°F)	106 / 111 Ah
3 hr capacity to 1.75VPC @ 20/25°C (68/77°F)	123 / 127 Ah
8 hr capacity to 1.75VPC @ 20/25°C (68/77°F)	136 / 138 Ah
10 hr capacity to 1.80VPC @ 20/25°C (68/77°F)	137 / 139 Ah
Float voltage @ 20/25°C (68/77°F)	2.28 / 2.27 VPC
Impedance (1Khz)	2.5 mΩ @ 25°C (77°F)
Conductance	2066 S
Short circuit current	3940 A
Operation temperature range	-40°C to +65°C
Nominal voltage	12 V

Technical Drawing

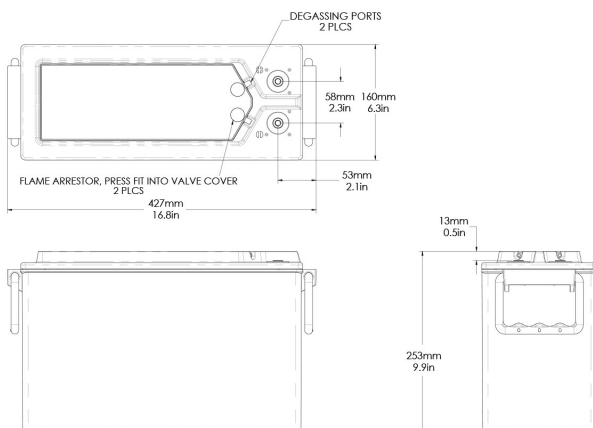

All NorthStar batteries are compliant with: Telcordia SR4228, IEC 60896; Bellcore GR-63-Core, Issue 1; British, German, and Russian telecom standards; UL approved and UN2800 certified. NorthStar is registered to ISO 9001 and ISO 14001.

NorthStar Americas PARTIAL
NorthStar Battery Company LLC
4000 Continental Way
Springfield, MO, 65803,
United States of America
info@northstarbattery.com
Tel: +1 417 575 8200
Fax: +1 417 575 8250

NorthStar Europe
SiteTel Sweden AB
Haukadalsgatan 8A
SE-164 40 Kista,
Stockholm, Sweden
europe@northstarbattery.com
Tel: +46 8 410 102 00
Fax: +46 8 638 06 00

NorthStar Middle East, Africa
NorthStar Battery DMCC
Office 702, Saba 1 Tower
Jumeirah Lake Towers, Dubai
United Arab Emirates
mea@northstarbattery.com
Tel: +971 4 423 8060
Fax: +971 4 423 8061

NorthStar Asia-Pacific
NS Asia Pacific Sdn. Bhd.
B2-3A-13A, Solaris Dutamas
No. 1, Jalan Dutamas 1, 50480
Kuala Lumpur, Malaysia
asia@northstarsitetel.com
Tel: +60 3 6419 0711