

Pure Lead - High Rate



The NSB UPS Battery® delivers superior performance at high discharge rates down to <15 mins.

- Performance excels at high rates of discharge and recharge
- Pure lead electrochemistry greatly increases temp and corrosion resistance while reducing component aging
- Thin plates deliver large surface area high power density and low resistance
- Design life 15+ years at 20°C (68°F)
- EUROBAT design life definition: Very Long Life (12+ years)
- High energy density
- Operating temperature range -40°C to +65°C (-40°F to 149°F)
- State-of-the-art automated manufacturing ensures consistency and reliability
- Advanced 3 stage terminal design to ensure leak-free operation - brass terminals provide maximum performance
- High modulus Polyphenylene Oxide (PPO) plastic materials designed to withstand extended elevated operating temperatures and maintain high battery compression essential for reliable operation
- Non-halogenated thermally sealed plastic casing
- Approved as non-hazardous cargo for ground sea and air transport DOT 49CFR173.159(d), (i) and (ii)

NSB 12-650RT

Nominal Technical Specifications

Electrical

Terminal	Female M8 x 1.25	Terminal torque	8.0 Nm (71 in-lbs)
4C (15min) power to 1.67 VPC	649 Watts/Cell	Float voltage	2.28 VPC
Shelf life	up to 24 months	Conductance	2300 S
Impedance (1Khz)	2.3 mΩ @ 25°C (77°F)	Short circuit current	5000 A
Operation temperature range	-40°C to +65°C	Nominal voltage	12 V
Silver equivalent	NSB 12-590FT	Capacity	W/cell (15 min)

Dimensions

Height	280 mm	Width	125 mm
Length	560 mm	Weight	54 kg

Constant Power Discharge Ratings (WPC @ 25°C/77°F)

Duration (minutes) (watts/cell @ 25°C/77°F)

End of discharge (Volts)	2 min	5 min	10 min	15 min	20 min	30 min	45 min	60 min	120 min
1.75	1238	1019	757	604	505	383	283	225	125
1.70	1384	1104	803	634	526	395	289	229	126
1.67	1468	1151	827	649	536	401	292	231	127
1.65	1521	1179	841	658	543	404	294	232	127
1.60	1643	1240	871	676	555	411	298	234	128

Technical Drawing

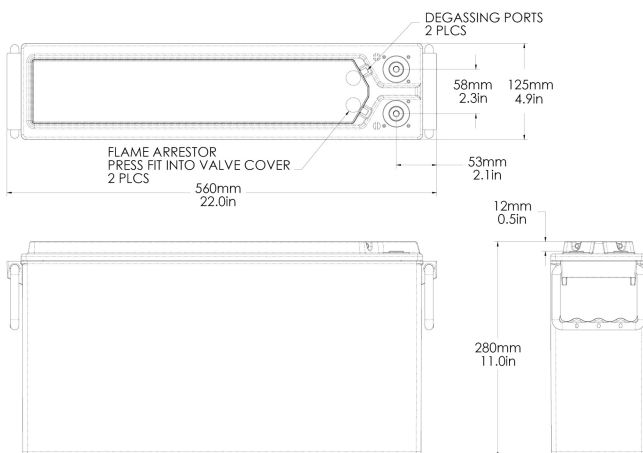

All NorthStar batteries are compliant with: Telcordia SR4228, IEC 60896; Bellcore GR-63-Core, Issue 1; British, German, and Russian telecom standards; UL approved and UN2800 certified. NorthStar is registered to ISO 9001 and ISO 14001.

NorthStar Americas PARTIAL
NorthStar Battery Company LLC
4000 Continental Way
Springfield, MO, 65803,
United States of America
info@northstarbattery.com
Tel: +1 417 575 8200
Fax: +1 417 575 8250

NorthStar Europe
SiteTel Sweden AB
Haukadalsgatan 8A
SE-164 40 Kista,
Stockholm, Sweden
europe@northstarbattery.com
Tel: +46 8 410 102 00
Fax: +46 8 638 06 00

NorthStar Middle East, Africa
NorthStar Battery DMCC
Office 702, Saba 1 Tower
Jumeirah Lake Towers, Dubai
United Arab Emirates
mea@northstarbattery.com
Tel: +971 4 423 8060
Fax: +971 4 423 8061

NorthStar Asia-Pacific
NS Asia Pacific Sdn. Bhd.
B2-3A-13A, Solaris Dutamas
No. 1, Jalan Dutamas 1, 50480
Kuala Lumpur, Malaysia
asia@northstarsitetel.com
Tel: +60 3 6419 0711